

# Goulotte de câblage SES® avec fentes latérales et perforations du fond





GF-A6/4

## GF-A6/4

<b>Matière :</b>	PVC rigide qualité 9051
<b>Coloris :</b>	gris RAL7030
<b>Températures d'utilisation :</b>	-5 à +65°C
<b>Densité :</b>	1,56
<b>Résistivité transversale :</b>	10 <sup>15</sup> Ω.cm
<b>Rigidité diélectrique :</b>	15 kV/mm
<b>Spécifications :</b>	V0 UL94 CSTB:M2
<b>Longueur standard :</b>	2 mètres
<b>Ruban double face :</b>	sur demande
<b>Minimum livrable :</b>	1 emballage complet (couvercles inclus)



type	goulottes code article	 m	dimensions ext.		nombre de fils par goulotte (remplissage 50 %)			couvercles (seuls) code article	 m
			H mm	L mm	1 mm <sup>2</sup>	1,5 mm <sup>2</sup>	2,5 mm <sup>2</sup>		
GF-A6/4 23x 30	0845 0010 013	48	23	30	36	29	24	0845 0610 013	24
GF-A6/4 23x 43	0845 0020 013	24	23	43	55	45	38	0845 0615 013	24
GF-A6/4 25x 20	0845 0030 013	48	25	20	25	21	17	0845 0605 013	48
GF-A6/4 35x 20	0845 0040 013	48	35	20	38	31	26	0845 0605 013	48
GF-A6/4 35x 30	0845 0050 013	48	35	30	59	49	41	0845 0610 013	24
GF-A6/4 35x 43	0845 0060 013	24	35	43	91	75	62	0845 0615 013	24
GF-A6/4 42x 20	0845 0070 013	48	42	20	46	38	31	0845 0605 013	48
GF-A6/4 42x 30	0845 0080 013	48	42	30	73	60	50	0845 0610 013	24
GF-A6/4 42x 43	0845 0090 013	24	42	43	111	91	76	0845 0615 013	24
GF-A6/4 42x 60	0845 0100 013	24	42	60	160	132	110	0845 0620 013	24
GF-A6/4 42x 80	0845 0110 013	24	42	80	219	180	150	0845 0625 013	24
GF-A6/4 42x120	0845 0120 013	12	42	120	336	276	231	0845 0635 013	12
GF-A6/4 50x 30	0845 0130 013	48	48,5	30	85	70	59	0845 0610 013	24
GF-A6/4 50x 43	0845 0140 013	24	48,5	43	130	107	89	0845 0615 013	24
GF-A6/4 50x 60	0845 0150 013	24	48,5	60	188	154	129	0845 0620 013	24
GF-A6/4 60x 20	0845 0160 013	48	60	20	67	55	46	0845 0605 013	48
GF-A6/4 60x 30	0845 0170 013	48	60	30	108	89	74	0845 0610 013	24
GF-A6/4 60x 43	0845 0180 013	24	60	43	164	134	112	0845 0615 013	24
GF-A6/4 60x 60	0845 0190 013	24	60	60	236	194	162	0845 0620 013	24
GF-A6/4 60x 80	0845 0200 013	24	60	80	322	264	221	0845 0625 013	24
GF-A6/4 60x100	0845 0204 013	24	60	100	403	331	277	0845 0630 013	12
GF-A6/4 60x120	0845 0210 013	12	60	120	493	405	338	0845 0635 013	12
GF-A6/4 80x 30	0845 0220 013	24	80	30	143	118	98	0845 0610 013	24
GF-A6/4 80x 43	0845 0230 013	24	80	43	218	179	150	0845 0615 013	24
GF-A6/4 80x 60	0845 0240 013	24	80	60	216	260	217	0845 0620 013	24
GF-A6/4 80x 80	0845 0250 013	24	80	80	431	354	296	0845 0625 013	24
GF-A6/4 80x100	0845 0254 013	12	80	98	531	436	365	0845 0630 013	12
GF-A6/4 80x120	0845 0260 013	12	80	120	662	544	454	0845 0635 013	12
GF-A6/4 100x 30	0845 0280 013	24	100	30	175	144	120	0845 0610 013	24
GF-A6/4 100x 60	0845 0290 013	24	100	60	392	322	269	0845 0620 013	24
GF-A6/4 100x 80	0845 0300 013	12	100	80	537	441	369	0845 0625 013	24
GF-A6/4 100x100	0845 0270 013	12	100	100	671	551	461	0845 0630 013	12
GF-A6/4 100x150	0845 0271 013	12	100	150	1043	856	716	0845 0636 013	12

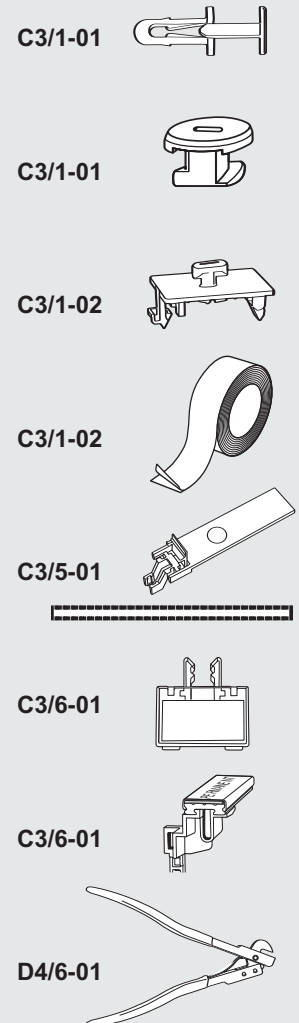
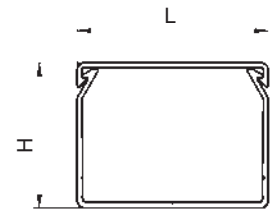

**GF-A6/4**

H = 23 mm  
H = 25 mm  
H = 35 mm  
H = 42 mm  
H = 50 mm  
H = 60 mm  
H = 80 mm

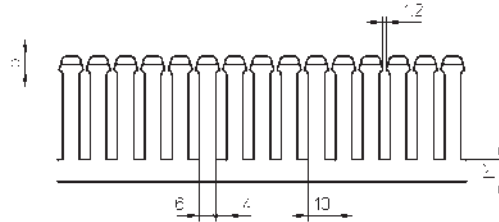
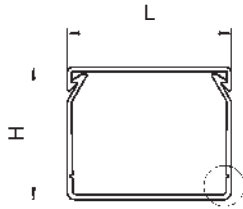

L = 20, 30, 43 et 60 mm

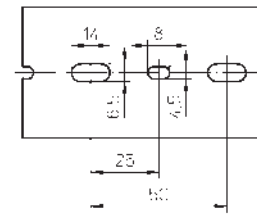

H = 100 mm

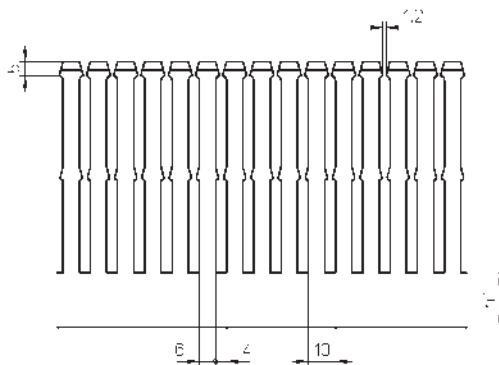
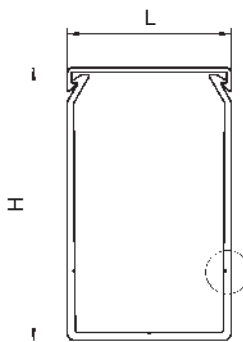

L = 80, 100, 120 et 150 mm

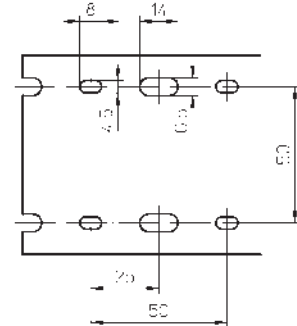

Perforations du fond selon DIN 43659

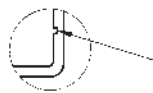

amorce de rupture  
des languettes

H (mm)	23	25	35	42	42	50	60	60	60	80	100
L (mm)	30 - 43	20	20...43	20	30...120	30...60	20	30...60	80...120	30...120	30...150
h1 (mm)	5	5	8	10	7	8	15	9	15	15	20

# Goulotte de câblage SES® avec fentes latérales et perforations du fond





GF-A12/8

## GF-A12/8

<b>Matière :</b>	PVC rigide qualité 9051
<b>Coloris :</b>	gris RAL7030
<b>Températures d'utilisation :</b>	-5 à +65°C
<b>Densité :</b>	1,56
<b>Résistivité transversale :</b>	10 <sup>15</sup> Ω.cm
<b>Rigidité diélectrique :</b>	15 kV/mm
<b>Spécifications :</b>	V0 UL94 CSTB:M2
<b>Longueur standard :</b>	2 mètres
<b>Ruban double face :</b>	sur demande
<b>Minimum livrable :</b>	1 emballage complet (couvertres inclus)
<b>Applications :</b>	utilisation pour câbles de grosses sections.



type	goulottes code article	 m	dimensions ext.		nombre de fils par goulotte (remplissage 50 %)			couvertres (seuls) code article	 m
			H mm	L mm	1 mm <sup>2</sup>	1,5 mm <sup>2</sup>	2,5 mm <sup>2</sup>		
GF-A12/8 100 x 100	0845 0276 013	12	100	100	671	551	461	0845 0630 013	12
GF-A12/8 100 x 150	0845 0273 013	12	100	150	1043	856	716	0845 0636 013	12

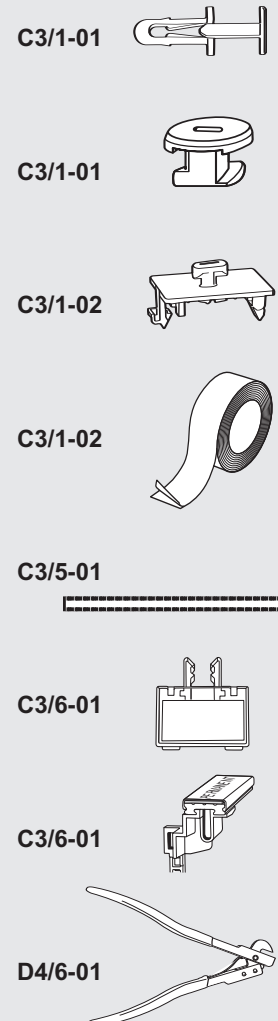
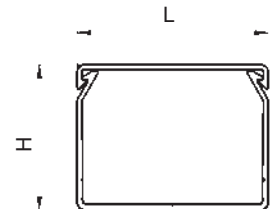

GF-A12/8

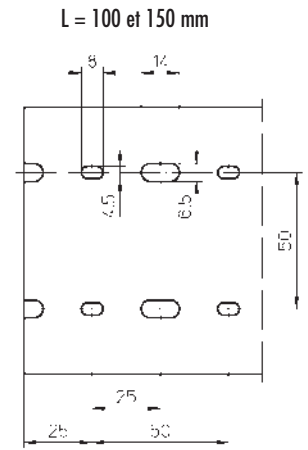
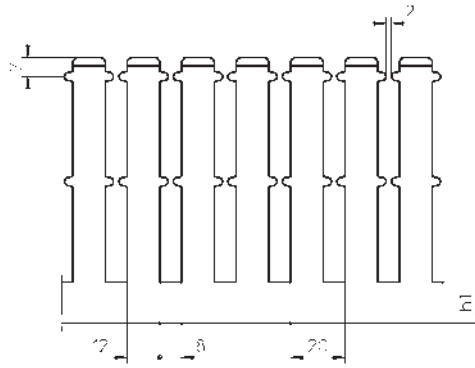
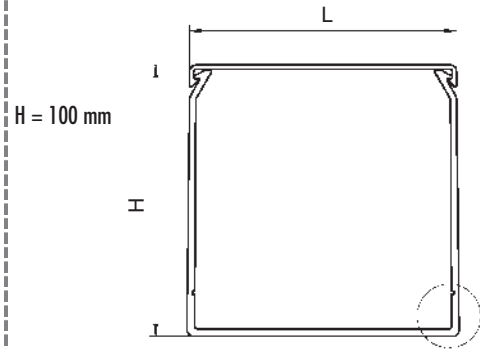

Perforations du fond selon DIN 43659

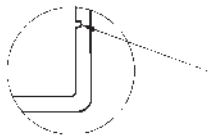

amorce de rupture  
des languettes

H (mm)	100
h1 (mm)	15

# Goulotte de câblage SES® avec fentes latérales et perforations du fond





GF-A6/4

## GF-A6/4 bleu

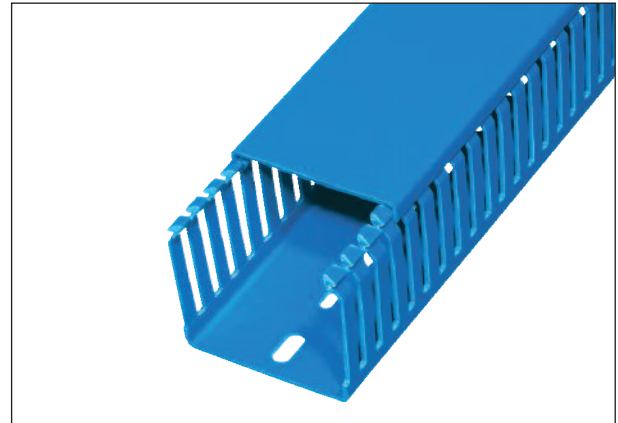
<b>Matière :</b>	PVC rigide qualité 9051
<b>Coloris :</b>	bleu ciel, RAL 5015
<b>Températures d'utilisation :</b>	-5 à +65°C
<b>Densité :</b>	1,56
<b>Résistivité transversale :</b>	10 <sup>15</sup> Ω.cm
<b>Rigidité diélectrique :</b>	15 kV/mm
<b>Spécifications :</b>	V0 UL94 CSTB:M2
<b>Longueur standard :</b>	2 mètres
<b>Ruban double face :</b>	sur demande
<b>Minimum livrable :</b>	1 emballage complet (couvercles inclus)
<b>Application :</b>	tableaux électriques à sécurité intrinsèque.



type	goulottes code article	 m	dimensions ext.		nombre de fils par goulotte (remplissage 50 %)			couvercles (seuls) code article	 m
			H mm	L mm	1 mm <sup>2</sup>	1,5 mm <sup>2</sup>	2,5 mm <sup>2</sup>		
GF-A6/4 23x 30	0849 0010 083	48	23	30	36	29	24	0849 0610 083	24
GF-A6/4 42x 20	0849 0070 083	48	42	20	46	38	31	0849 0605 083	48
GF-A6/4 42x 30	0849 0080 083	48	42	30	73	60	50	0849 0610 083	24
GF-A6/4 42x 43	0849 0090 083	24	42	43	111	91	76	0849 0615 083	24
GF-A6/4 42x 60	0849 0100 083	24	42	60	160	132	110	0849 0620 083	24
GF-A6/4 60x 30	0849 0170 083	48	60	30	108	89	74	0849 0610 083	24
GF-A6/4 60x 43	0849 0180 083	24	60	43	164	134	112	0849 0615 083	24
GF-A6/4 60x 60	0849 0190 083	24	60	60	236	194	162	0849 0620 083	24
GF-A6/4 60x 80	0849 0200 083	24	60	80	322	264	221	0849 0625 083	24
GF-A6/4 60x120	0849 0210 083	12	60	120	493	405	338	0849 0635 083	12
GF-A6/4 80x 30	0849 0220 083	24	80	30	143	118	98	0849 0610 083	24
GF-A6/4 80x 43	0849 0230 083	24	80	43	218	179	150	0849 0615 083	24
GF-A6/4 80x 60	0849 0240 083	24	80	60	216	260	217	0849 0620 083	24
GF-A6/4 80x 80	0849 0250 083	24	80	80	431	354	296	0849 0625 083	24
GF-A6/4 100x 60	0849 0290 083	24	100	60	392	322	269	0849 0620 083	24
GF-A6/4 100x100	0849 0270 083	12	100	100	671	551	461	0849 0630 083	12

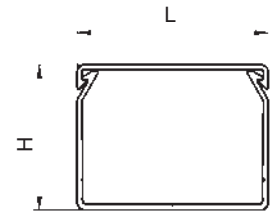

C3/1-01

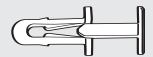

C3/1-01



C3/1-02

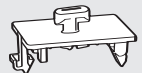

C3/1-02

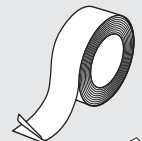

C3/5-01

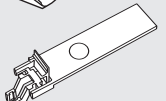

C3/6-01

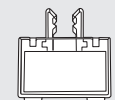

C3/6-01

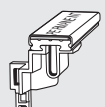

D4/6-01

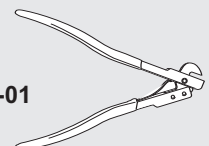

**GF-A6/4**

H = 23 mm  
H = 42 mm  
H = 60 mm  
H = 80 mm

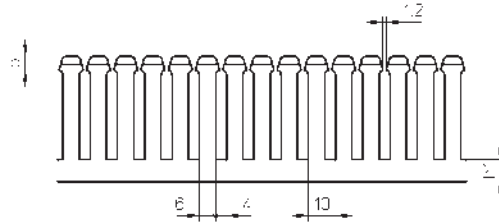
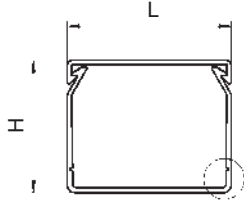

L = 20, 30, 43 et 60 mm

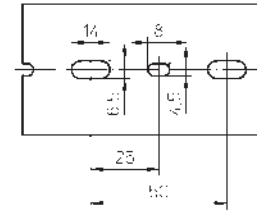

H = 100 mm

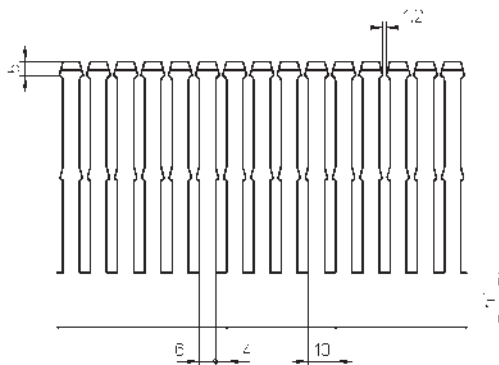
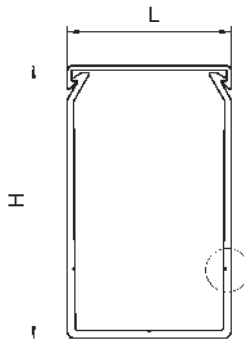

L = 80, 100 et 120 mm

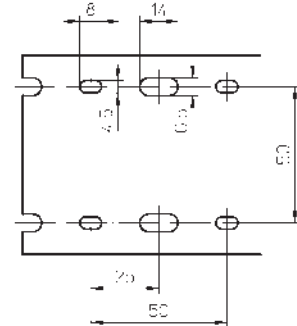

Perforations du fond selon DIN 43659

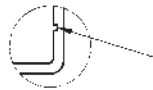

amorce de rupture  
des languettes

H (mm)	23	42	42	60	60	80	100
L (mm)	30	20	30...60	30...60	80 - 120	30...80	60...100
h1 (mm)	5	10	7	9	15	15	20