

Embase CH-X / CB-S

Matière : polyamide 6
Coloris : noir
Températures d'utilisation : -20 à +70°C
Tenue au feu : V2 UL94

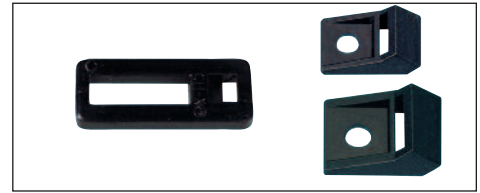

type	code article	pour attaches largeur maxi mm	fixation par vis Ø mm	
CH-X	0127 0031 010	4,7	5	50

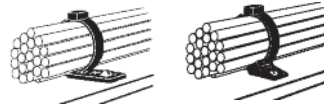
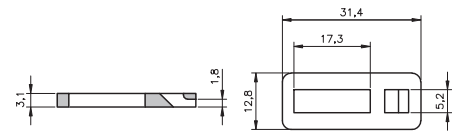

type	code article	dimensions (mm)			pour attaches largeur maxi mm	fixation par vis Ø mm	
		A	B	C			
CB-S8	0127 0046 010	2,5	8	19	7,6	4	50
CB-S12	0127 0050 010	2,8	9,2	23,5	9	5	50

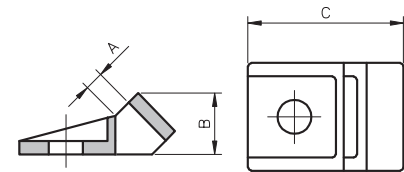

Embase-berceau TM

Matière : polyamide 6.6
Coloris : naturel - noir
Températures d'utilisation : -40 à +85°C
Tenue au feu : V2 UL94

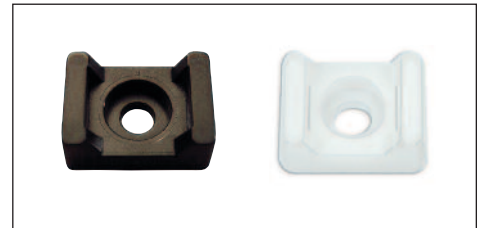
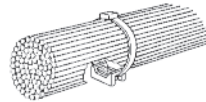

type	code article		dimensions (mm)			pour attaches largeur maxi mm	fixation par vis Ø mm	
	naturel	noir	A	B	C			
TM-2S6	0186 0925 018	0186 0925 010	6,9	9,5	14,9	4,7	3,5	100
TM-2S8	0186 0926 018	0186 0926 010	6,9	9,5	14,9	4,7	4,3	100
TM-3S8	0186 0930 018	0186 0930 010	9,7	15,9	22,2	9	4	100
TM-3S10	0186 0530 018	0186 0530 010	9,7	15,9	22,2	9	4,5	100

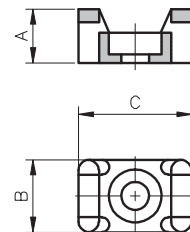

Embase-berceau CH-935

Matière :	polyamide 6 (PA6)	polyamide 12 (PA12)
Coloris :	noir	noir
Températures d'utilisation :	-20 à +70°C	-40 à +60°C
Tenue au feu :	V2 UL94	HB UL94



type	code article	matière	pour attaches largeur maxi mm	fixation par vis Ø mm	
CH-935-6	0189 0536 010	PA 6	9	5	100
CH-935-12	0189 0535 010	PA 12	9	5	100

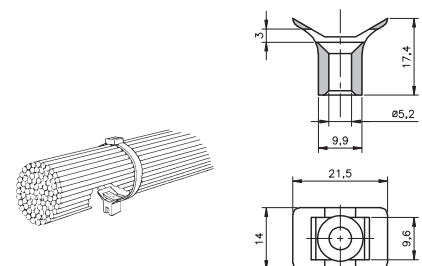



Embase à visser CH-S / CH-S8

Matière : polyamide 6
Coloris : noir
Températures d'utilisation : -20 à +70°C
Tenue au feu : V2 UL94

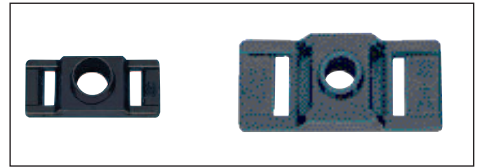
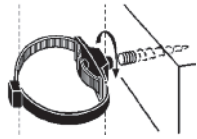

type	code article	ØA	dimensions (mm)				E	pour attaches largeur maxi mm	fixation par vis Ø mm	
			B	C	D					
CH-S	0127 0038 010	5,6	5,5	9	8,5	22	4,7	5,6	50	
CH-S8	0127 0039 010	5,3	9	10	15	34	9	5,3	50	

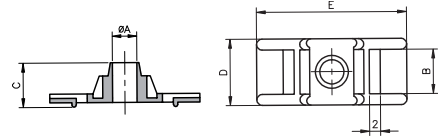

Embase double CH-936

Matière : polyamide 6 (PA6) / polyamide 12 (PA12)
Coloris : noir / noir
Températures d'utilisation : -20 à +70°C / -40 à +60°C
Tenue au feu : V2 UL94 / HB UL94



type	code article	matière	pour attaches largeur maxi mm	
CH-936-6	0189 0516 010	PA 6	2 x 9	100
CH-936-12	0189 0515 010	PA 12	2 x 9	100
CH-V	0127 0048 010	PA 6	2 x 9	50
CH-W	0127 0047 010	PA 6	1x 25 + 1x 9	50

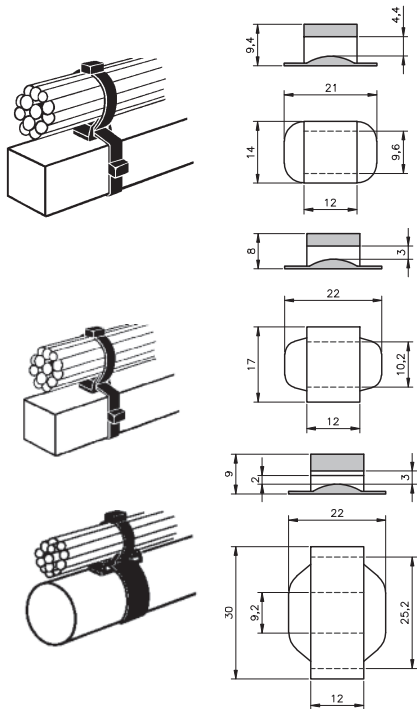

Embase à cheville CH-C8

Matière : polyamide 12 noir
Coloris : noir
Températures d'utilisation : -40 à +60°C
Tenue au feu : HB UL94

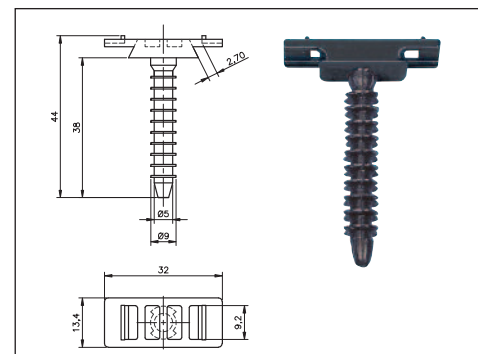
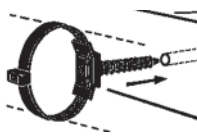

type	code article	pour attaches largeur maxi mm	Ø perçage mm	
CH-C8	0127 0045 010	9	7	50

